



DJI AVATA 2 LIGHT SYSTEM

P/N 700-325

PRODUCT MANUAL

TABLE OF CONTENTS

INTRODUCTION

Overview	3
Physical Characteristics	3
Reference Guide	4 - 5

BATTERY

Charging the Battery	6
----------------------	---

OPERATIONAL MODES

Operational Modes	6
Modes, Output & Battery Life	6

INSTALLATION	7
---------------------	---

CARE/CLEANING	8
----------------------	---

WARNINGS/WARRANTY	8 - 9
--------------------------	-------

CONTACT FOXFURY	9
------------------------	---

OVERVIEW

DJI Avata 2 Light System consists of multiple mounts and lights including the D10 and D3060 models for the DJI Avata 2 drone.

The D10's 30° LED beam pattern operates on continuous or strobe light modes. This rechargeable and splashproof light is durable and compact for a variety of uses where light is needed in a tight space. All lights rotate 360° for optimum light placement.

The D3060 is a multi-function utility light. It mounts to most drones via D Series Flat Mounting Pad with provided VHB Tape. Its 30° and 60° dual LEDs can operate with a high, low, or strobe mode to provide omni-directional lighting. This rechargeable and waterproof light is durable and compact for a variety of uses where light is needed in a tight space.

IMPORTANT!

Please fully charge the D10 and D3060 lights before using the first time. Please read this manual before using your DJI Avata 2 Light System as it relays beneficial operating and safety Information.

PHYSICAL CHARACTERISTICS

D10 Light

DIMENSIONS	1.07 x 0.77 x 1.4 in (27.3 x 19.5 x 36 mm)
WEIGHT	0.42 oz (12 g)

D3060 Light

DIMENSIONS	1.3 x 2.3 x 0.9 in (33 x 58 x 23 mm)
WEIGHT	1.1 oz (31.2 g)

D Series Flat Mounting Pad







DIMENSIONS	1.14 x 1.06 x 0.2 in (29 x 27 x 5 mm)
WEIGHT	0.06 oz (1.7 g)

DJI Avata 2 Mount

DIMENSIONS	2.3 x 1.83 x 1.56 in (58.8 x 46.5 x 39.5 mm)
WEIGHT	0.04 oz (11.6 g)

REFERENCE GUIDE

WHAT'S INCLUDED

-  DJI Avata 2 Mount
 -  D10 Light (2 ea)
 -  D3060 Light
 -  D Series Flat Mounting Pad
 -  USB-C Cable
 -  Micro USB Cable (2 ea)
 -  5915 VHB Tape
-

D10 LIGHT

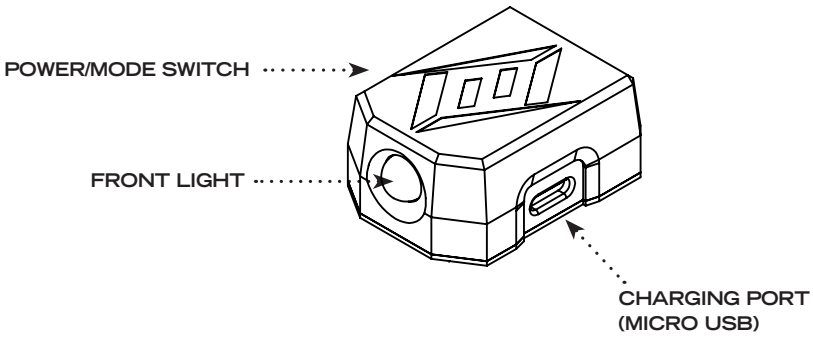

360° SWIVEL

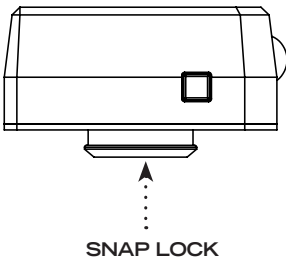

AVATA 2 MOUNT

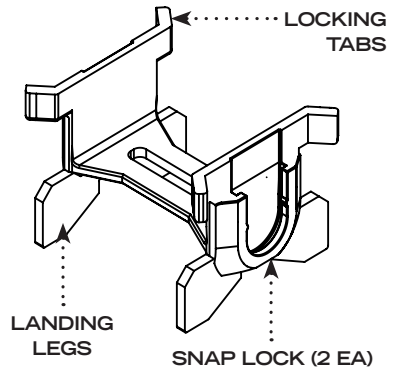

REFERENCE GUIDE

D3060 LIGHT

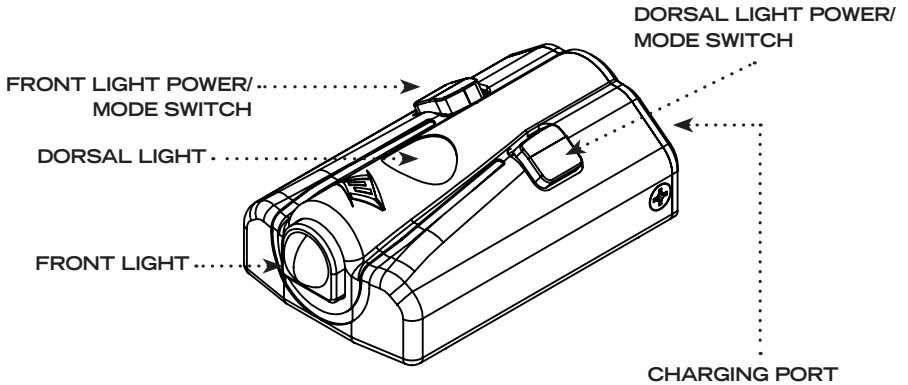

CHARGING PORT



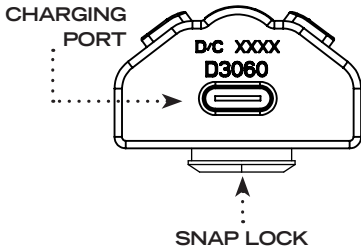

USB-C

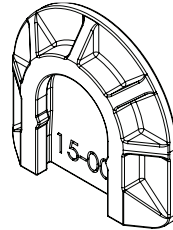

FLAT MOUNTING PAD



WARNINGS

-  Please fully charge the D10 and D3060 before using for the first time.
-  Do not stare into the LEDs for long periods of time or from a close range (less than 2 ft / 0.6 m).
-  While using any FoxFury product, please operate at safe speeds.
-  It is the responsibility of drone/UAV users to follow the FAA and global laws and regulations and/or the laws and regulations applicable to the flight location.

BATTERY

CHARGING THE BATTERY

- ❖ Connect the provided USB Cable to the Charging Port, and to a USB source.
- ❖ While charging, a green light will blink for D10, or a red light will be on for D3060. Once charged, the green light will remain steady on.
- ❖ Charge time should be approximately 1 hour (D10) or 1.5 hours (D3060).

WARNING:

- ⚠ Unplug the light once charged to avoid impacting battery life.
- ⚠ If battery is fully discharged because the unit may have not been in use for many months, please charge fully.

OPERATIONAL MODES

D10

- ❖ Press and hold Power/Mode Switch for 3 seconds to turn light ON.
- ❖ Press Power/Mode Switch again to turn the light to STROBE.
- ❖ Press the Power/Mode Switch again to turn light OFF.

MODE	LUMENS	BATTERY LIFE
ON	200	30 - 40 minutes
STROBE	200	60 - 80 minutes

D3060

- ❖ Press the Dorsal Light Power/Mode Switch once to turn the Dorsal Light on to HIGH.
- ❖ Press the Power/Mode Switch again to turn the Dorsal Light to LOW.
- ❖ Press the Power/Mode Switch again to turn the Dorsal Light to STROBE.
- ❖ Press the Power/Mode Switch again to turn the Dorsal Light OFF.
- ❖ Do the same with the Front Light Power/Mode Switch to control the Front Light.

LIGHT	MODE	LUMENS	BATTERY LIFE
FRONT LIGHT ONLY	HIGH	200	1.5 hours
	LOW	60	2.5 hours
	STROBE	200	2 hours
DORSAL LIGHT ONLY	HIGH	160	1.7 hours
	LOW	50	3 hours
	STROBE	160	2 hours
BOTH FRONT AND DORSAL LIGHTS	LOW	60 FRONT 50 DORSAL	2 hours
	STROBE	200 FRONT 160 DORSAL	1.5 hours

Thermal protection circuit will automatically reduce the Dorsal Light to low mode when the Front Light is on high mode. The battery life for this setup is 1 hour.

INSTALLATION

DJI AVATA 2 MOUNT AND D10 LIGHTS

1 Align the bottom Snap Lock of the D10 with the mount's Snap Lock and press/snap the D10 in place. Lightly spin and tug the D10 to make sure it is properly retained within the detent. Repeat these steps on the opposite side of the mount.

2 Attach the mount onto the DJI Avata 2 drone.

Push the mount upward from beneath the drone. A slight pinch of the landing feet may widen the opening of the mount to allow for an easier attachment. The Locking Tabs will help align the mount into a proper fit.

Confirm the mount is hooked properly to the drone and secured before flight by giving the mount a slight jostle back and forth.

3 Remove the mount from the DJI Avata 2 drone.

Pull/Twist one side of the mount away from the drone. A slight pinch of the landing feet may help to loosen the grip to the drone. Once loose, continue pulling the other half of the mount until it is free from the drone.

NOTE:

When charging, D10 can either be removed from the mount or remain installed.

FLAT MOUNTING PAD AND D3060

1 The included D Series Flat Mounting Pad can be installed on the top of the drone or in an alternate location based on the user's preference or application.

2 Remove the protective plastic from included VHB Tape. Attach VHB Tape to the flat side of the Flat Mounting Pad. Remove the other protective plastic, and place the Flat Mounting Pad to desired location on the drone. Press firmly for good adhesion and trim if necessary.

3 Align the bottom of the D3060 Light with the snap lock location on the mount and snap the light in place. Spin them and tug to make sure they are properly attached before flight.

NOTE:

Before our accessories are made available, they are tested internally and verified externally by a minimum of 2 professional users. We have experienced multiple cases of UAS (drone) mechanical modifications from manufacturers within the same P/N and revision, and without providing warnings or product updates. If there is a fit problem, please contact our customer service department at <https://www.foxfury.com/contact/>

WARRANTY AND OTHER INFORMATION

PRODUCT DURABILITY



PRODUCT NAME & PART NUMBER:

DJI Avata 2 LIGHT SYSTEM

P/N: 700-325

CARE/CLEANING





Your FoxFury product is a professional tool. Regular maintenance and care of your light will maximize performance for you. As needed, clean your FoxFury product using a damp soft washcloth. Do not immerse.

ACCESSORIES

-  D Series Mount Set, P/N 850-730

WARNINGS

FoxFury, LLC is not responsible for the incorrect use of any FoxFury Lighting product.

-  Lights are strong enough to cause damage to the human eye.
-  Do not stare into LEDs for long periods of time or from a close range (less than 2 ft / 0.6 m).
-  FoxFury, LLC is not responsible for any injury or damage caused during the use of this product.
-  Usage of this product must be supervised by an adult when it is being used by a minor.

-  Any FoxFury product should be operated at speeds safe enough to maneuver around surrounding obstacles.

-  Do not use under the influence of drugs or alcohol.

ONE YEAR WARRANTY

FoxFury, LLC (“FoxFury”) warrants this product to be free from defects in material for one year after purchase. LiPo batteries have a one year pro-rated or 300 re-charge cycle pro-rated warranty, whichever the user reaches first.

This warranty is given only to the original end user of the accompanying product. If you purchased a product from someone other than an authorized FoxFury reseller/distributor or if the product was used, (including but not limited to demo models, show models or refurbished product by someone other than FoxFury) prior to your purchase, you are not the Original Purchaser and the product that you purchased is not covered by this warranty. This warranty is VOID if this Product has been altered or modified in any way (including but not limited to attempted warranty repair without authorization from FoxFury and/or alteration/removal of the serial number). To expedite warranty concerns, we encourage the end user to register their FoxFury Product at www.foxfury.com/resources/product-information/product-registration/

THIS IS THE ONLY WARRANTY,
EXPRESSED OR IMPLIED,
INCLUDING ANY WARRANTY OF
MERCHANTABILITY OR FITNESS
FOR A PARTICULAR PURPOSE.
INCIDENTAL, CONSEQUENTIAL
OR SPECIAL DAMAGES ARE
EXPRESSLY DISCLAIMED EXCEPT
WHERE SUCH LIMITATION IS
PROHIBITED BY LAW.

You may have other specific legal
rights which vary by jurisdiction. Go to
[www.foxfury.com/resources/product-
information/warranty/](http://www.foxfury.com/resources/product-information/warranty/) for a complete
copy of the warranty. Retain your
receipt for proof of purchase.

CONTACT FOXFURY

FoxFury, LLC

Oceanside, CA 92056 USA

Tel: 760.945.4231

Email: service@FoxFury.com

Web: FoxFury.com

All FoxFury products are designed in
Oceanside, CA. All FoxFury products
are manufactured with the highest
quality USA and foreign parts.
Products are assembled in either
FoxFury's controlled plant in Asia or the
USA, under strict quality control.

CALIFORNIA PROPOSITION 65

This product can expose you to
chemicals including Lead and DEHP,
which are known to the State of
California to cause cancer and
birth defects or other reproductive
harm. For more information go to
www.P65Warnings.ca.gov.

